

2018 FLEETWOOD JAMBOREE

JAMBOREE

2018 FLEETWOOD
CLASS C GAS



 **FLEETWOOD RV**
REV GROUP

JAMBOREE

The Fleetwood Jamboree redefines the category with a long list of features that break the mold of Class C design. With amenities like a roof-mounted integrated box patio awning, whole-coach LED flush-mount ceiling lighting and an 11 cu. ft. two-door stainless-steel residential refrigerator, it's easy to see why Jamboree is quickly becoming the new favorite with Class A amenities that pack a Class C punch.

TOP FEATURES

- Aluminum Square Luggage Doors
- Exterior Wall-Mounted Entertainment Center
- Color Monitor for Side and Rear Cameras
- Dynamic Ride Suspension
- Roof-Mounted Integrated Awnings
- 11 cu. ft. Whirlpool Stainless-Steel Residential Refrigerator
- Stainless-Steel Microwave
- Solid-Surface Countertops
- Energy-Efficient, Flush-Mount LED Ceiling Lights Throughout



Jamboree 31U is shown in Rum Raisin décor and Autumn Wheat High Gloss cabinetry.



FLOORPLANS & EXTERIOR OPTIONS

30D

Options: 113, 146, 157, 351, 860/864

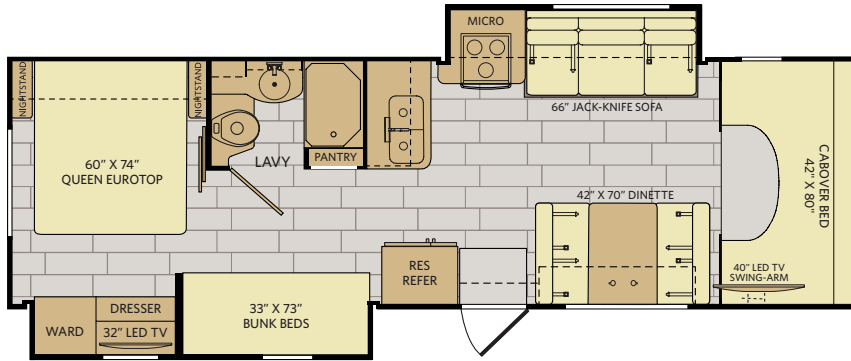

30F

Options: 113, 146, 351

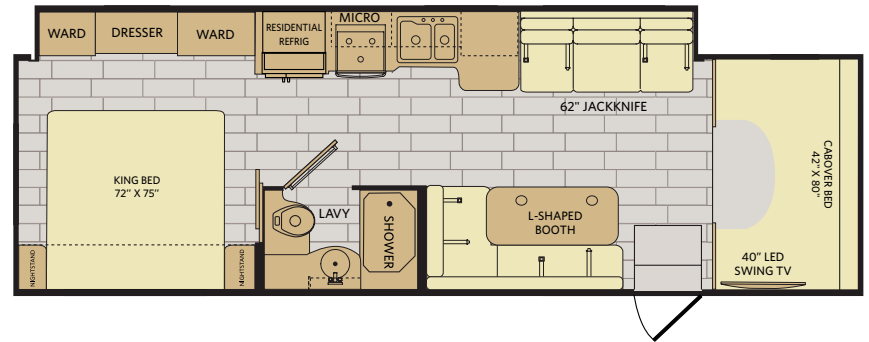

31U

Options: 113, 146, 351

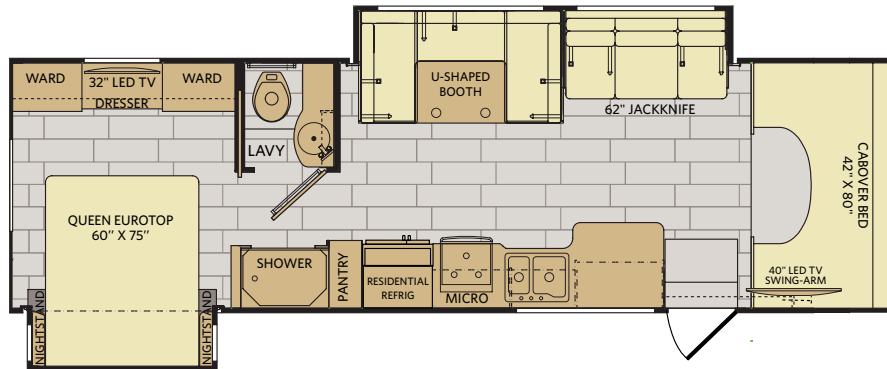

Available Options



OPT. 113
3-BURNER
COOKTOP
W/OVEN



OPT. 146
2-DOOR REFRIG
W/ICEMAKER

OPT. 157
DUAL FLAT
PANEL MONITORS
BUNK AREA

OPT. 351
40" LED TV
W/HOME
THEATER SYSTEM

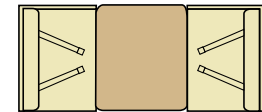

OPT. 860/864
DINETTE W/ SWING DOWN BUNK
30" X 70" DINETTE / 28" X 70" BUNK

Shale



Tuscan



Cadmium



Flint



DÉCOR OPTIONS

Autumn Wheat High Gloss



Infinity Sterling

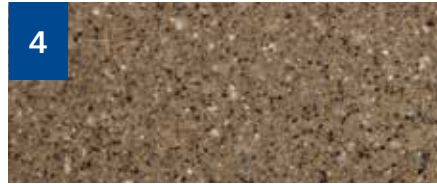
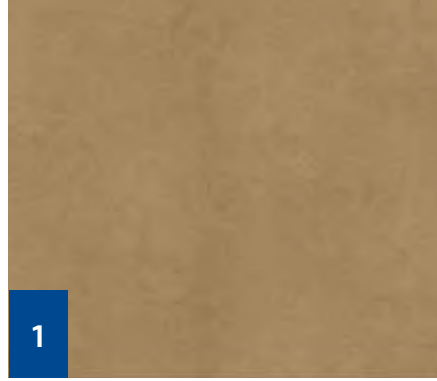

Nottingham Cherry High Gloss



Rum Raisin

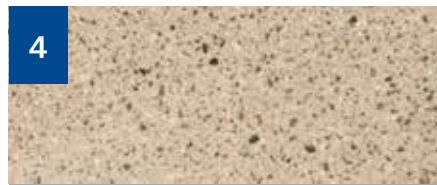

1 Sofa 2 Accent 3 Bedspread 4 Countertop 5 Flooring 6 Carpet

STANDARD & OPTIONS

INTERIOR THROUGHOUT

- (1) 15,000 Btu Ducted Air Conditioner w/Heat Pump
- 6 Gallon Propane/120V Water Heater w/Electronic Ignition
- 30,000 Btu/h Single Furnace
- Child Tether Seating Position
- 1200W Inverter
- Deluxe Padded Ceiling
- Energy Efficient LED Flush Mount Ceiling Lighting Throughout
- Full Extension Drawers
- Hardwood, High Gloss Raised Panel Cabinet Doors/Drawers Upper & Lower
- Hardwood Slide-out Fascia
- Hidden Cabinet Door Hinges
- Night Roller Shades Throughout
- Soft Touch Sofa & Dinette Seating
- Whole Coach Water Filtration System

OPTIONS

- CSA Package

DRIVER CONVENIENCE

- 12V & USB Accessory Ports
- 3 Point Seat Belts at Driver and Front Passenger Seats
- AM/FM Radio w/CD Player
- Auxiliary Emergency Start Assist Switch on Dash
- Cab Carpet
- Cup Holders - 2 Holders in Dash
- Dash Air Conditioning
- Driver & Passenger Sun Visors
- Electronic Cruise Control
- Front Cab Closeout Fabric Curtain
- Front Cab Dome Light
- Power Driver & Passenger Windows
- Power Locks
- Power Remote/Heated Mirrors w/Side View Camera
- Reclining Driver & Passenger w/Soft Touch Recovered Seats
- Safety Air Bags Driver & Passenger
- Tilt Steering Column
- Windshield Wipers w/Delay

OPTIONS

- Sirius/XM Satellite Radio

GALLEY

- 11 cu.ft. Two-Door Stainless Steel Residential Refrigerator
- 3 Burner Cooktop w/Glass Cover
- Deep Double Bowl Under Mount Stainless Sink
- Full Length Roller Bearing Drawer Guides
- Indirect Under Cabinet Lighting
- Night Roller Shade
- Power Vent
- Residential Single Handle Faucet w/Pullout Sprayer
- Tile Backsplash
- Solid Surface Galley Countertop
- Solid Surface Sink Covers
- Stainless Steel Convection Microwave

OPTIONS

- 3 Burner Range w/Oven
- Dometic 8 cu. ft. Two-Door Refrigerator w/Ice-maker

LIVING ROOM

- 40" Flat Screen LED TV
- Soft Touch Dinette w/Child Tether
- Soft Touch Jack-knife Sofa

OPTIONS

- Front Cab Hardwood Overhead w/Entertainment System & Cabinets

BEDROOM

- 33" x 76" Bunk Bed Mattress (30D)
- 32" LED TV
- Bunk Bed Bedspreads and Privacy Curtains (30D)
- Designer Bedspread, Pillow Shams & Pillows
- DVD Player
- Lift Up Bed with Under Bed Storage
- Queen Size Mattress
- Solid Surface Nightstand Tops

- Under Cabinet Reading Lights

OPTIONS

- Flat Panel TVs Bunkbeds (30D)
- Swing Down Bunkw/Dinette (30D)
- Swing Down Bunk w/Dinette & Dual Glazed Windows (30D)

BATHROOM

- Medicine Cabinet w/ Mirror
- Porcelain Foot-flush Toilet
- Power Vent
- Premium Vinyl Flooring
- Residential Brushed Nickel Faucet
- Shower Head w/On/Off and Matching Dual Valve Faucet
- Shower Skylight
- Solid Surface Countertop



EXTERIOR THROUGHOUT

- 14 Gallon LP Tank
- Acrylic Lighted Grab Handle at Entry Door
- Aluminum Square Baggage Doors
- Batteries: (2) 6V Deep Cycle House Batteries
- Black Water Tank Flush
- Front Chrome Bumper
- Color Match Exterior w/Premium Graphics
- Dark Tinted Frameless Windows Throughout
- Daytime Running Lights
- Debris Awning Above All Slide-Out Rooms
- Exterior Lighted Power Entry Step
- Exterior Park Cable & Hookup
- Exterior Shower
- Front and Rear LED Clearance Lighting
- GFCI Receptacle
- Hitch - Capacity of 7,500# w/7-Way Round Tow Connection
- Patio lights - (One door side, One passenger side over service bay)
- Onan® 4.0kW MicroQuiet Generator
- Prep for Roof Mount Satellite Dish
- Propane Quick Connect
- Rear Ladder
- Running Boards
- Roof Mounted Integrated Box Patio Awning w/ LED Lighting
- Solar Electrical Panel Prep
- Unidirectional Antenna
- Wall Mounted Exterior Entertainment Center w/32" LED TV, AM/FM/CD/DVD Radio, & 2 Speakers

OPTIONS

- Frameless Dual Pane Windows
- King Dome Satellite
- Roof Rain Vent Covers
- Full Body Paint Exterior

AUTOMOTIVE

- 4-Point Automatic Levelers
- Trailer Hitch w/7-Pin Electrical Hook-Up

SAFETY/CONVENIENCE

- 10 lb. ABC Fire Extinguisher
- 30 Amp Electrical Service & 30' Power Cord
- Automotive Safety Glass
- Battery Access Entry Step Cover
- Battery Disconnect
- Carbon Monoxide, Propane, and Smoke Detector/Alarm
- Egress Window
- Entry Door w/Screen Door & Deadbolt Lock
- Exterior & Interior Entry Assist Handle
- GFI Circuit Protection
- High Mounted Large Taillights
- Multiple Seatbelt Locations
- Porch Light w/Interior Switch
- Power Electric Step

STORAGE

- Molded Cross Link Polyethylene
- Battery Compartment w/Lid
- Pass Through Storage
- Rotocast Molded Storage Boxes
- Slam Latch Luggage Doors

BODY STRUCTURE

- 26" Wide Radius Corner Entry Door w/Obscured Window
- Corrosion Resistant Aluminum Tube Hull Framing
- Full Basement Exterior
- Heated Fresh Water & Holding Tank Compartments
- Molded Rear Wheel Trim Flares
- One-Piece Molded Fiberglass Front End Cap
- Pass Through Storage
- Powder Coated, Steel Running Boards
- Radius Roof
- Sidewalls Framed with 1-1/2" Aluminum Tubing
- Steel Powder Coated Rear Bumper
- Vacu-bond® Floor
- Vacu-bond® Hull Lamination Process

WEIGHTS & MEASUREMENTS

CHASSIS

MODEL	30D	30F	31U
Wheelbase	214"	214"	214"
Front GAWR (lbs) ²	5,000	5,000	5,000
Rear GAWR (lbs) ²	9,600	9,600	9,600
GCWR (lbs) ³	22,000	22,000	22,000
Hitch Rating Weight (lbs) [†]	7,500	7,500	7,500
Tongue Weight (lbs) ⁴	500	500	500
Fuel Capacity (gal)	55	55	55

FORD® CHASSIS

Model: Ford E-450

Engine: 6.8L Triton V10

Transmission: TorqShift® 6-Speed, Automatic w/Overdrive

Alternator: 155 Amp

Torque: 420 lb.-ft. @ 3250 RPM

Horsepower: 305 HP

DIMENSIONS AND CAPACITIES

MODEL	30D	30F	31U
Overall Length ⁴	31' 8.5"	31' 8.5"	32' 5.5"
Overall Height ^{5,6}	12'	12'	12'
Overall Width ^{5,6}	102"	102"	102"
Interior Height (maximum)	82"	82"	82"
Interior Width (maximum)	96"	96"	96"
Patio Awning Length	16' 4"	16' 4"	16' 4"
Interior Storage (cu. ft.)	110	110	115
Exterior Storage (cu. ft.)	104	104	90
Fresh Water Holding Tank (gal)	60	49	49
Grey Water Holding Tank (gal)	35	35	35
Black Water Holding Tank (gal)	35	35	35
Appliance Propane Tank (gal) (WC) ⁷	14	14	14
Water Heater Tank (gal)	6	6	6

THE SMOOTHEST CLASS C RIDE FEATURING REV CONTROL RYDE™

Our all-new Class C motorhome rides on the industry exclusive REV Control Ryde™ (RCR) suspension system. Partnering with MORryde we use the rubber shackle 'airless' suspension system - the newest suspension system to the Class C market. The RCR Suspension system takes systems engineered for the ambulance and emergency vehicle industry to offer Class C owners a ride like no other. Owner's can skip airbag maintenance with the RCR System, which tackles the roughest roads with unique rubber shear springs that cushion the motorhome and absorbs road shock. We also offer the industry's only 'Anti-dive' technology which brings superior control during braking through reduced front end dive.

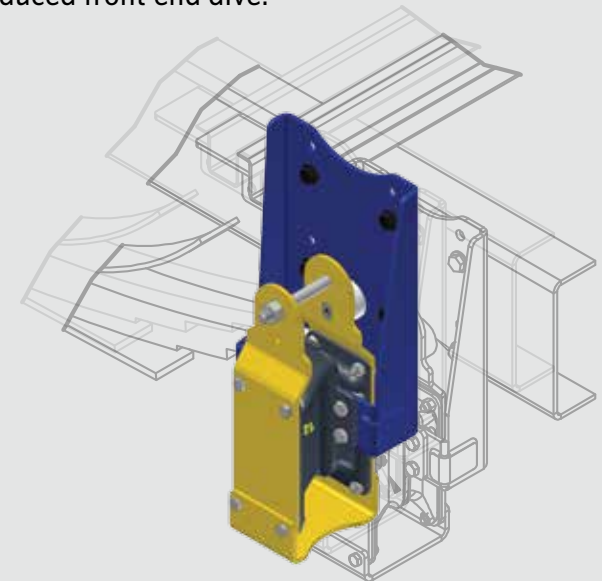

21 REASONS WHY FLEETWOOD IS AMERICA'S FAVORITE

Mile after mile, decade after decade, more families trust Fleetwood. The open road is our proof. With more Fleetwood motorhomes on the road today than any other manufacturer*, our brand prides itself on building dependable products that help families reconnect one journey at a time — over and over again. At Fleetwood, we constantly redefine value because understanding your every need is just the start to delivering peace-of-mind at every turn.

F-21 Advantage: Fleetwood 21st century engineering, manufacturing, and materials

Fleetwood RV offers a 21st century, industry-leading advantage—a quality construction approach to motorhome engineering, manufacturing and materials. The “F” stands for Fleetwood RV. The “21” stands for 21st century materials and construction techniques. F-21 is demonstrated by 21 key proof points that deliver unique advantages to Fleetwood owners and illustrate the quality for which Fleetwood RV is known industry-wide.

*Based on IHS Automotive, Polk Recreational Vehicles in Operation (RVIO) as of 7/1/13.



YOUR LOCAL DEALER



Fleetwood RV is part of REV Recreation Group, a division of REV Group, Inc., a family of 26 industry-leading motor vehicle brands. At REV Group, we innovate, design and build products that connect and protect thousands of people every day—our trusted vehicles are engineered with the utmost rigor and precision to deliver the highest levels of performance, reliability, durability and safety.

DISCLAIMERS

1. GVWR (Gross Vehicle Weight Rating) is the maximum permissible weight of this fully loaded motor home. The GVWR is equal to or greater than the sum of the (UVW) unloaded vehicle weight plus the (OCCC) occupant cargo-carrying capacity.
 2. GAWR (Gross Axle Weight Rating) is the maximum permissible loaded weight a specific axle is designed to carry.
 3. GCWR (Gross Combined Weight Rating) is the value specified by the motor home manufacturer as the maximum allowable loaded weight of this motor home with its towed vehicle. Towing and braking capacities may be different. Refer to Fleetwood and chassis manufacturer's manuals for complete information.
 4. Length measured from front bumper to rear bumper (excludes accessories).
 5. Excludes safety equipment and awnings.
 6. Motor homes feature a body width over 96" which will restrict your access to certain roads. Before purchasing, you should research any state and/or province road laws which may affect your usage.
 7. Tank manufacturer's listed water capacity (WC). Actual propane capacity is 80% of water listing as required by the safety code.
- † The chassis manufacturer recommends the installation of a supplemental brake control system to activate the brakes on the vehicle or trailer you are towing. Hitch receiver ratings expressed are maximum for the hitch receiver installed and may require the purchase of additional equipment that is dependent on the weight of the towed load. Consult with hitch receiver manufacturer for further information.
- * UVW and OCCC are found on the label containing the federal certification tag in each RV.
- ** Seatbelts and locations are shown in the brochure for display purposes only. Actual numbers and locations will vary by model.
- *** All 2018 REV Recreation Group motorhomes include a limited one year/15,000-mile coach warranty and three-year/45,000-mile structural warranty, whichever occurs first, and is fully transferable for the first 12 months.

FLEETWOOD MOTORHOME ASSOCIATION

As a Fleetwood RV owner, you're invited to become a member of the Fleetwood Motorhome Association (FMA). Becoming a member is the perfect way to meet other Fleetwood owners who love to travel across America and share in the RV lifestyle. Visit the FMA website at www.fma4fun.org to learn more and join the fun.

CONTACT US

To locate a dealer near you, visit our website at www.fleetwoodrv.com or call 1-800-322-8216. We can also be contacted at Fleetwood RV Customer Relations, P.O. Box 1007, Decatur, IN 46733.

IMPORTANT—PLEASE READ: Product information, photography and illustrations included in this publication were as accurate as possible at the time of printing. For further product information and changes, please visit our website at www.fleetwoodrv.com or contact your local Fleetwood RV dealer. Prices, materials, design and specifications are subject to change without notice. All weights, fuel, liquid capacities and dimensions are approximate. Fleetwood RV has designed its recreational vehicles to provide a variety of uses for its customers. Each vehicle features optimal seating, sleeping, storage and fluid capacities. The user is responsible for selecting the proper combination of loads (i.e., occupants, equipment, fluids, cargo, etc.) to ensure that the vehicle's capacities are not exceeded.

www.fleetwoodrv.com

©2017 REV Group, Inc. Printed in the USA. Inventory Control Number JAMBOREE18B1, 06/17. Model Year 2018, First Edition.